

Three colored circles (dark teal, light teal, grey) and a vertical line are positioned to the left of the main title.

Infopeople Webcast Series

Internet Filters: A Three Part Series

Infopeople is supported by the U.S. Institute of Museum and Library Services under the provisions of the Library Services and Technology Act, administered in California by the State Librarian. Any use of this material should credit the author and funding source.

Internet Filtering: Light Switches or Dimmers?

Contract Webcast for the State
Library of North Carolina
January 2004

Presenter: Lori Bowen Ayre
LBAyre@galecia.com



Technical Housekeeping

- Use Chat window to ask questions or post to group



- Click IM button to send a private message



- For technical problems, send IM to **HorizonHelp**
- Evaluation pops up during Q&A; please fill it out
- Webcast is being archived; will be available on Infopeople's website tomorrow



Agenda for Today

- Filtering in Libraries
- Filtering Strategies
- How Filters Work
- The Dimmers: Content Categories
- Alternatives to Categories

Libraries Already Use Filters



Looking for something to read? You've come to the right place.

[Enter the Just for Kids site](#)



How CIPA Changes How Libraries Use Filters

The Children's Internet Protection Act (CIPA) mandates that anyone receiving E-Rate discounts *on their Internet access costs* must filter all their computers, including staff computers.

“install a technology protection measure that protects against visual depictions of material that is obscene, child pornography or harmful to minors”

Current Dilemma

Filter all library
computers

-- or --

Say "No" to E-Rate
discounts

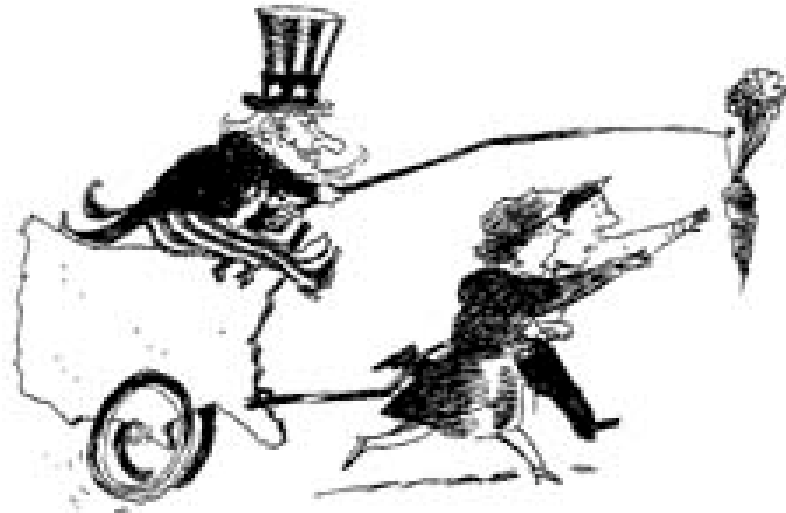

Is E-Rate Discount Worth it?

- Determine “total cost of ownership”
 - use ALA worksheets to compare CIPA discount against costs of filtering
- If it is worthwhile to comply, develop your new filtering strategy

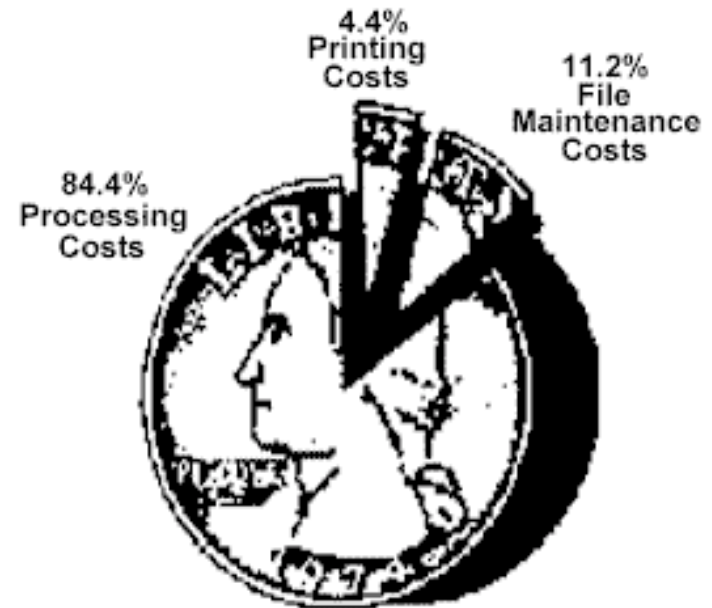



What is a “Filtering Strategy”

How the filter will be used to reinforce the library’s Internet Use Policy, including

- restricting content
- restricting activities
- managing overrides
- filtering some groups differently

Filter Strategy 1: Minimalist

Block “visual depictions”
of CIPA-mandated
content for all users

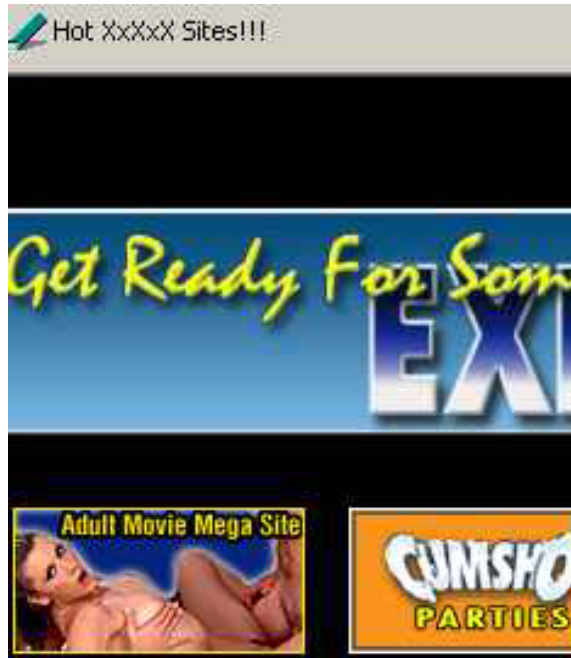

Page with
Images
turned OFF



Filter Strategy 2: Single CIPA List - Block Entire Page

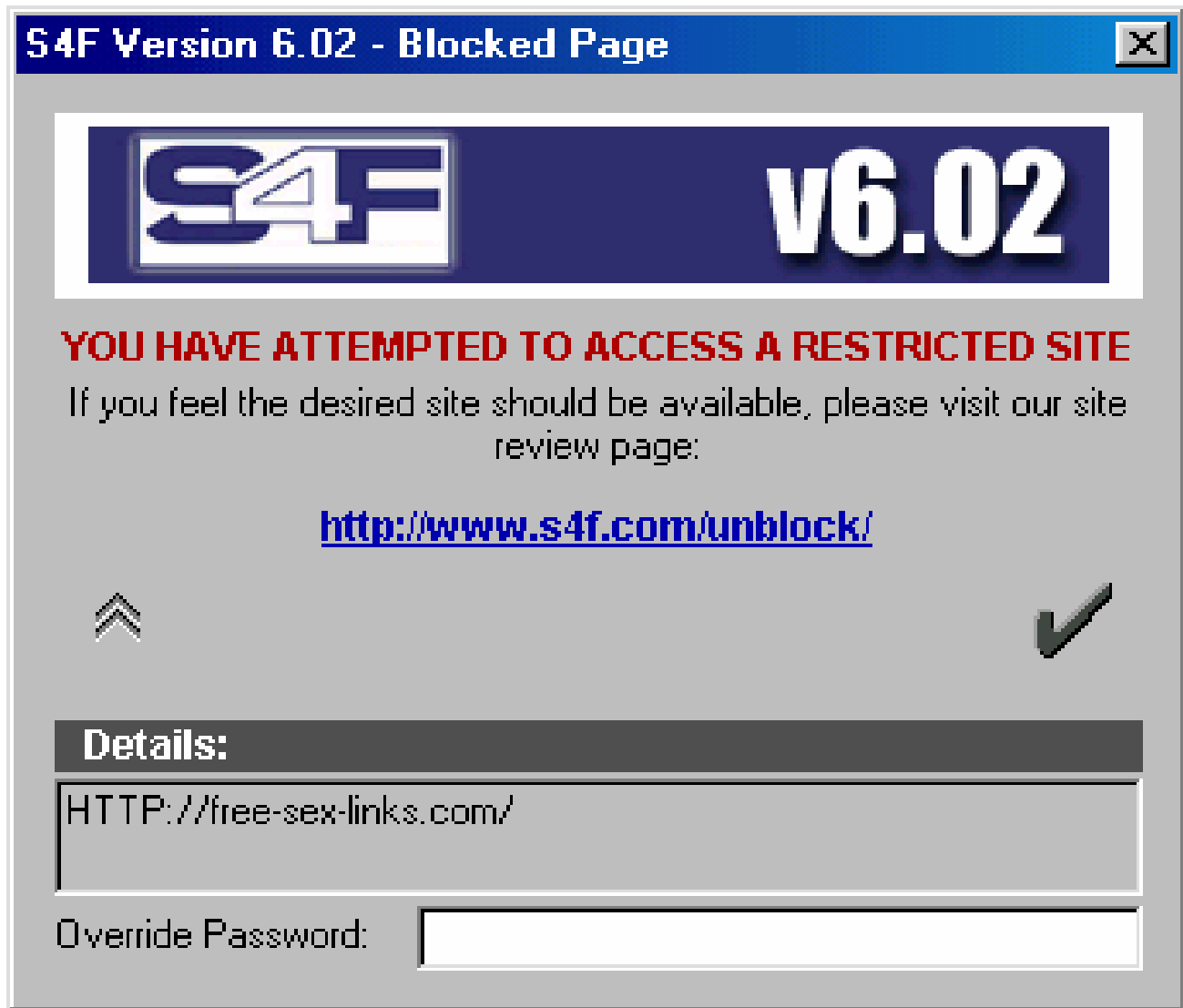

Filter Strategy 3: Multiple Filter Profiles

Block
different
groups of
library
users
differently

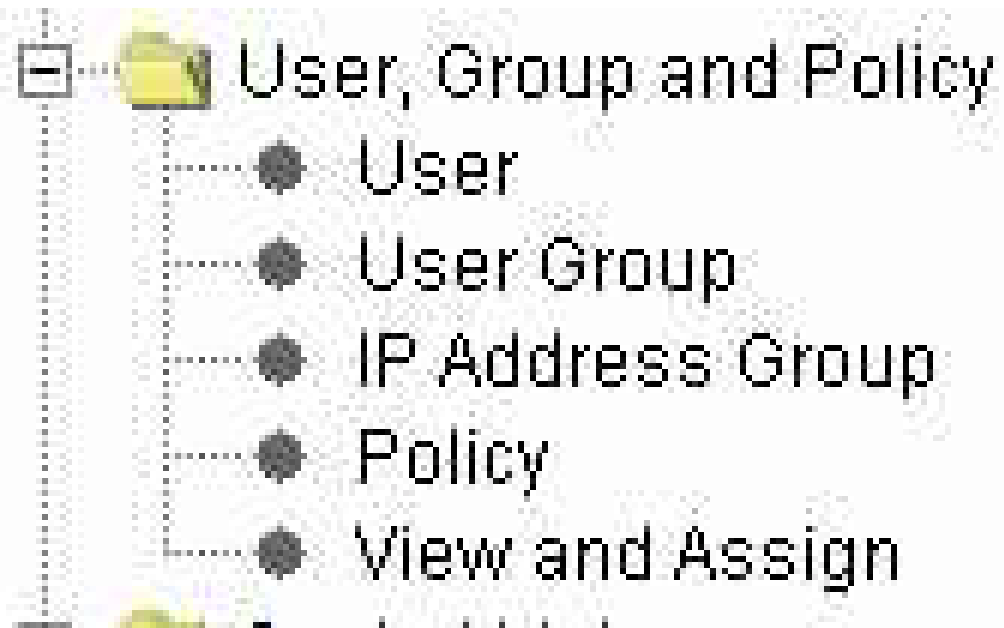



How Filters Work – The Early Years

Keyword Blocking in action...

“The Catholic Church
opposes homosexual
marriage.”

“The Catholic Church
opposes marriage.”

How Filters Work Today

List of URLs

angelfire.com/nh/irvmelissa
sinobyte.com/users/ginger
chez.com/fatgirlpics
chez.com/lessexbombes
mylinea.com/bdiffusion/
209.85.122.172/photos/photosxxx
makebling.com/galleries/wsg/56
w1.860.telia.com/~u86010534
watergoddess.com/cockshard/avs
shura.virtualave.net/cgi-bin
chez.com/qonline
hem.bredband.net/berndtzen/
inch.com/~snack/ginger
home7.swipnet.se/~w-76228/ass
tonsilhockey.com/new-year/two
chez.com/csex2/
pornstarsiteshq.com/blacks-on-
bewoner.dma.be/carmelec
groupmature.com/movies/020
free-porn-pictures-xxx-movies.com/ra
ardcore-xxx.htm

Analyze Content



URL Filtering

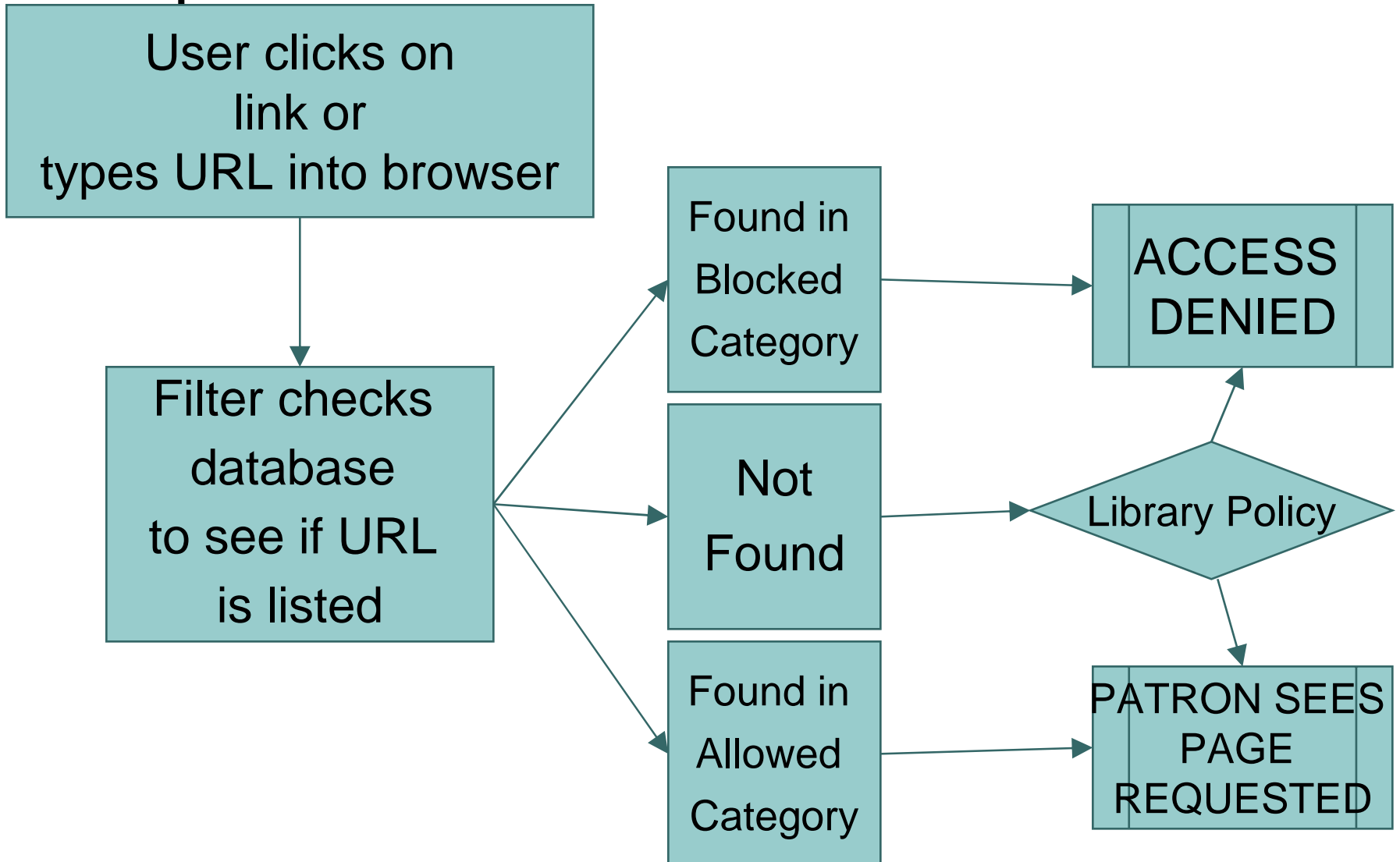

File Edit View Favorites Tools Help



Back



Search



Favorites

Address



<http://barenakedladies.com/>



Go



URL List

Pornography

members.shaw.ca/kirsten17/

216.15.136.128/babes

[www city.europeonline.com/nowonder/babe](http://www.city.europeonline.com/nowonder/babe)

terra.es/personal6/busty24/

pleasurehost.com/

Nudity

sitesgratuits.net/pages/charmes

sog10.com/gallery01/cf005_uu8

bekkoame.ne.jp/ro/last/new/pics

barenakedladies.com

CIPA Only Strategy

Filter Policy: block “pornography” for all

Found in
Allowed
Category

Page Displayed

 BNL :: BareNaked Ladies Official Website



Library's Filter Profiles

- Determine if Access is Permitted

Categories Being Blocked By Group

Adults
pornography

Teens
pornography
nudity

Children
pornography
nudity
violence

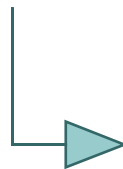

Content Filtering

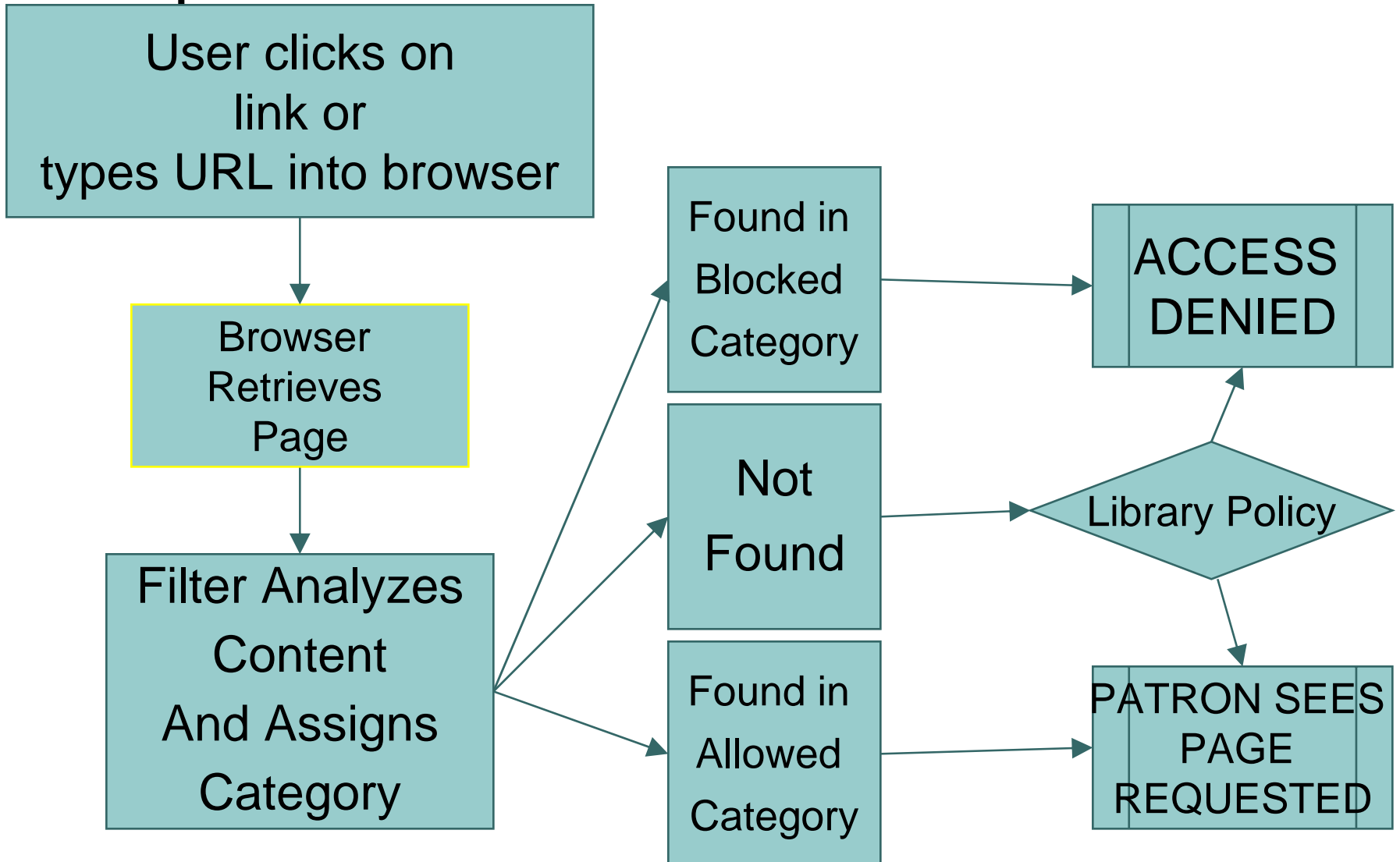

Artificial Content Recognition (ACR)

HTML Parser breaks down HTML code into hundreds of parameters such as individual words, background color, links, number of links, banner ads, number of images, number of words, average number of letters in word

Parameters make up Raw Data Vector (RDV)

Feature Extractor finds patterns in RDV and creates Processed RDV (PRDV).

PRDV is processed by Clustering Mechanism which generates mathematical coordinate which places page within corresponding cloud of pre-classified category of Web pages such as pornography, etc.

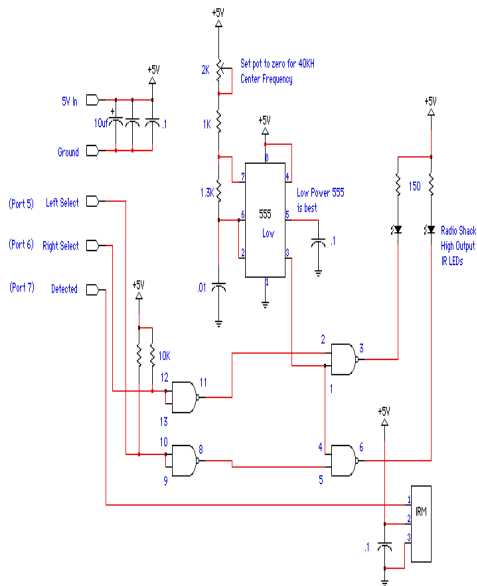



Type of Filter Doesn't Matter

- Most *URL filters* use “ACR” or something similar to
 - build their lists
 - “catch” missed sites
- Many *content filters* build databases of analyzed sites

Benefits of URL Filters

- Some
 - are free
 - URL lists can be shared
- All
 - less impact on network

Squidguard



Dan's Guardian

The Wacky World of Content Categories

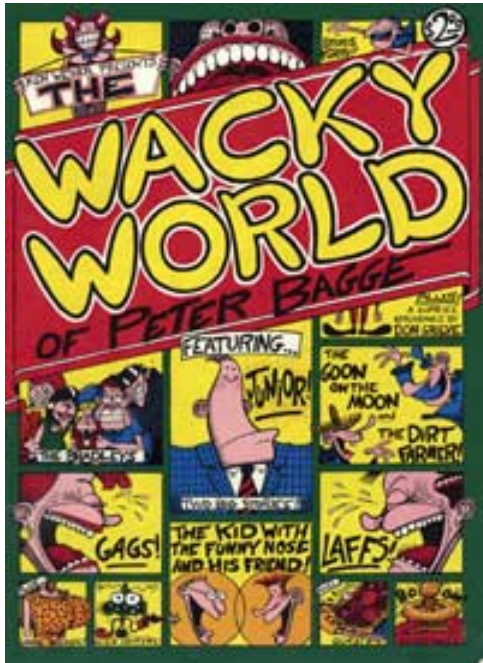

- Choose categories to block, not individual pages
- Can't see what's in the category
- Categories not based on any authority – business decision



Content Category Examples

- Pornography
- Racism / Hate
- Health
- Criminal Skills
- Religion
- Adult

Depending on the filter, there can be as few as six categories or as many as 70

Sexuality



This category contains those sites that provide information, images or implications of bondage, sadism, masochism, fetish, beating, body piercing or self-mutilation.

Religions



**Non-Traditional
Religions and Occult
and Folklore**

**Traditional
Religions**



Adult

Pornography,
escort services,
erotic fiction and
art, adult video
sales/rentals,
offensive material,
etc. e.g.
playboy.com,
playgirl.com



Do the Content Categories Work for You?

- Which categories would you block for adults?

- Young Adults?
- Staff?
- Children?



- Is there one category that will work for everyone if I just want to block CIPA-mandated content?



Links to Descriptions of Categories

Cerberian:

cerberian.com/content/CerberianCategories.pdf

iPrism:

stbernard.com/products/iprism/products_iprism-cats.asp

N2H2:

n2h2.com/products/categories.php

Smartfilter:

securecomputing.com/index.cfm?sKey=86

Websense:

websense.com/products/about/database/categories.cfm

Are Categories Accurate?

<u>URL</u>	<u>Current Categorization</u>	<u>Suggest a Change</u>
www.religioustolerance.org	Politics/Religion	<input type="text" value="None"/>
aclu.org	Politics/Religion	<input type="text" value="None"/>
smut.com	Sex	<input type="text" value="None"/>



Product Evaluation

Block as Few Categories as Possible

Kaiser Family Foundation study found

- number of categories selected for blocking more important than the filter being used
- default settings block much more content than is necessary to comply with CIPA



Don't Accept Minimal Default Settings



Sex

Pornography

Violence

Adults Only

Illegal

Hate/Discrimination



Pornography



Accuracy Worsens As Categories Are Selected for Blocking

	# Cats Blocked	% Over-blocked	# Cats Blocked	% Over-blocked
N2H2	1	.8%	15	6.5%
Smartfilter	2	2.3%	8	5.8%



Example Categories to Choose for CIPA Compliance

- N2H2 (32)
 - Pornography
- CyberPatrol (36)
 - Adult/Sexually Explicit
- DynaComm i:Filter
 - Adult
- Netpure
 - Adult
- SmartFilter (30)
 - Extreme
 - Sex
- 8e6 (30)
 - Pornography
- Websense (77)
 - Sex
- CyberSetting
 - Porn Group



Examples of Non-Content Categories

- Productivity

- Shopping
- Sports
- Travel
- Dating
- Entertainment
- Games
- News
- Investing
- Job Search

- Bandwidth

- Streaming Media
- Web Chat
- Games
- Peer to Peer Sharing
- Movie Trailers

The Filter Marketplace

- Business
 - prevent employees from “distractions”
 - prevent sexual harassment problems
 - monitor what employees do
- Parents, schools and religious groups
 - protect children from sexually explicit material
 - protect children from online predators
 - prevent access to “inappropriate” material

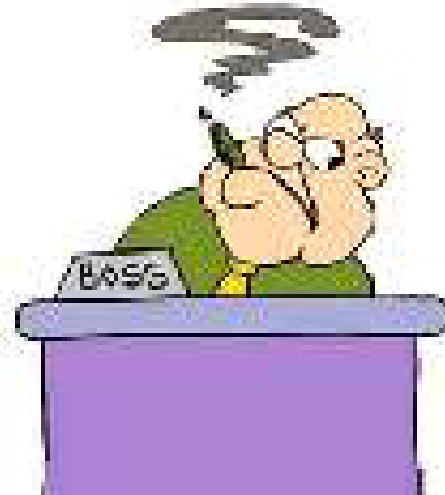

Alternatives to Categories

- Build your own CIPA block list



- open source software
- viewable list of URLs
- can share with other libraries



THE INTERNET FILTER

your world could be a better place

Content Advisor, PICs and Self-Rating Systems





Review

1. Is E-Rate worth it?
2. Review IUP and develop filter strategy
3. Find filter to suits strategy
 - single CIPA list
 - multiple profiles/content categories
4. Test list or categories for accuracy

Next Step: Evaluate features



Next Filtering Webcast

- Key Library Features
- Special CIPA Features
- Additional Features Needed Depending on Strategy
 - single block list
 - multiple filter profiles